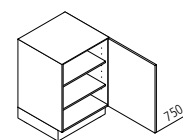
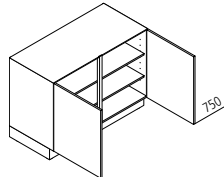
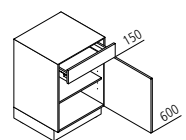
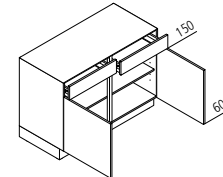
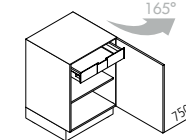
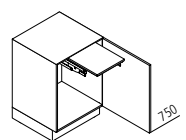
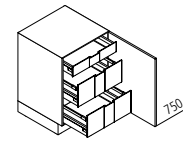
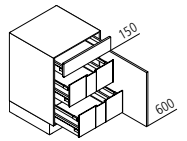
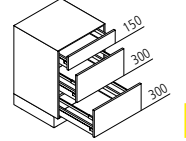
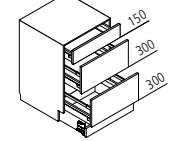
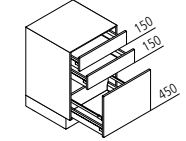
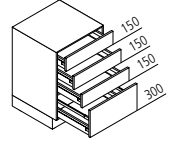
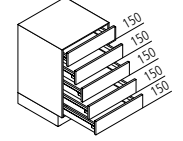
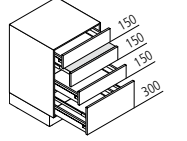
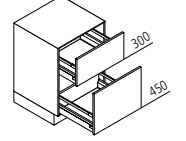
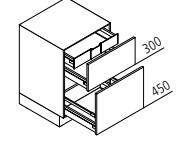
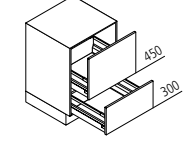
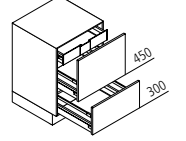

# Base units

750mm

					
<b>UDD Base unit</b>	<b>UDD Base unit</b>	<b>U Base unit</b>	<b>U Base unit</b>	<b>UDDI Base unit</b>	<b>UBKOD Bread-slicer unit</b>
↔ 30/35/40/45/50/60 ↓ 75 ↙ 60/50/39	↔ 80/90/100/120 ↓ 75 ↙ 60/50/39	↔ 30/40/45/50/60 ↓ 75 ↙ 60/50/39	↔ 80/90/100/120 ↓ 75 ↙ 60/50/39	↔ 40/45/50/60 ↓ 75 ↙ 60/50	↔ 45/50/60 ↓ 75 ↙ 60

					
<b>UIDD Base unit</b>	<b>UI Base unit</b>	<b>UAK Pull-out unit</b>	<b>UAKS Pull-out unit with large-capacity pull-out drawer</b>	<b>UAS Drawer base unit</b>	<b>USA Drawer base unit</b>
↔ 40/45/50/60 ↓ 75 ↙ 60/50/39	↔ 40/45/50/60 ↓ 75 ↙ 60/50/39	↔ 30/40/45/50/60/80/90/100/120 ↓ 75 ↙ 60/50/75/39	↔ 60/80/90/100 ↓ 75 ↙ 60	↔ 30/40/45/50/60/80/90/100/120 ↓ 75 ↙ 60/50/75/39	↔ 30/40/45/50/60/80/90/100/120 ↓ 75 ↙ 60/50/39

					
<b>US Drawer base unit</b>	<b>USAP Drawer base unit with work table</b>	<b>UZ Pull-out unit</b>	<b>UZI Pull-out unit</b>	<b>UAZ Pull-out unit</b>	<b>UAZI Pull-out unit</b>
↔ 30/40/45/50/60/80/90/100/120 ↓ 75 ↙ 60/50	↔ 60 ↓ 75 ↙ 60	↔ 30/40/45/50/60/80/90/100/120 ↓ 75 ↙ 60/50/75/39	↔ 30/40/45/50/60/80/90/100/120 ↓ 75 ↙ 60/50/75/39	↔ 30/40/45/50/60/80/90/100/120 ↓ 75 ↙ 60/50	↔ 30/40/45/50/60/80/90/100/120 ↓ 75 ↙ 60/50

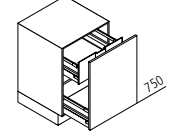
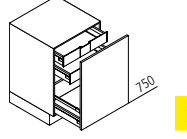
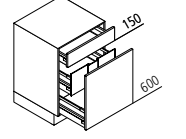
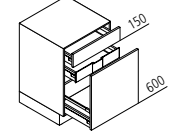
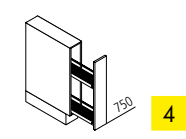
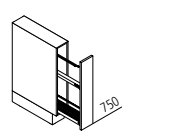
					
<b>UATDIA Pull-out unit</b>	<b>UATD Pull-out unit</b>	<b>UATIA Pull-out unit</b>	<b>UAT Pull-out unit</b>	<b>UKD Stile unit</b>	<b>UKTD Stile unit with towel rail</b>
↔ 30/40/45/50/60 ↓ 75 ↙ 60/50	↔ 30/40/45/50/60 ↓ 75 ↙ 60/50	↔ 30/40/45/50/60/80/90/100/120 ↓ 75 ↙ 60/50	↔ 30/40/45/50/60/80/90/100/120 ↓ 75 ↙ 60/50	↔ 15 ↓ 75 ↙ 60	↔ 15 ↓ 75 ↙ 60

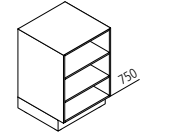
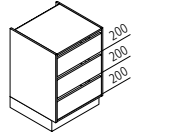
	
<b>UR Open shelf base unit</b>	<b>URI Open shelf base unit with drawers</b>
↔ 15/20/25/30/35/40/45/50/55/60 ↓ 75 ↙ 60/39	↔ 60/90 ↓ 75 ↙ 60

↔ Unit width  
↓ Unit height  
↙ Planning depth







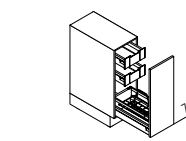
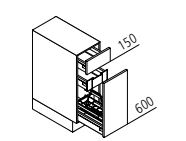
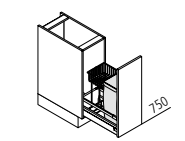
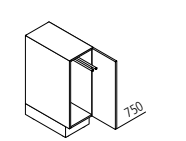
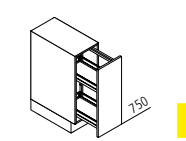

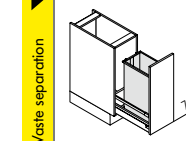
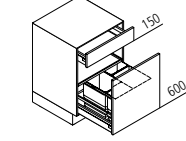
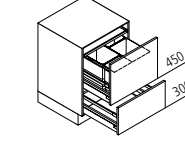
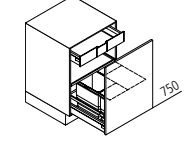
1 2 3 4 5

The base units in your Nolte kitchen give you numerous and extremely versatile design options – making sure you get precisely the storage space you need.

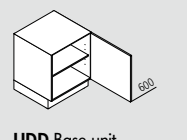
				
<b>UAID Pull-out unit</b>	<b>UAI Pull-out unit</b>	<b>UBD Pull-out unit with baguette and utensil insert</b>	<b>UTD Base unit with towel rails</b>	<b>UVK Pull-out unit with storage baskets</b>
↔ 30 ↓ 75 ↙ 60	↔ 30 ↓ 75 ↙ 60	↔ 30 ↓ 75 ↙ 60	↔ 30 ↓ 75 ↙ 60	↔ 30 ↓ 75 ↙ 60

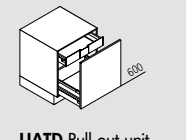
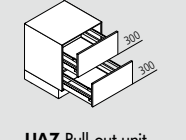
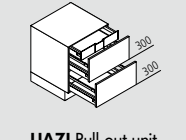
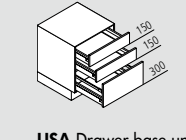
			
<b>UWSD Pull-out unit with holder for recyclable-waste bag</b>	<b>UABG Pull-out unit with waste bin</b>	<b>UABO Pull-out unit with waste bin</b>	<b>UABDG Pull-out unit with waste bin</b>
↔ 30 ↓ 75 ↙ 60	↔ 40/45/50/60 ↓ 75 ↙ 60	↔ 30/40/45/50/60 ↓ 75 ↙ 60	↔ 40/45/50/60 ↓ 75 ↙ 60

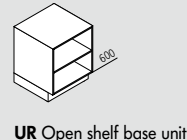
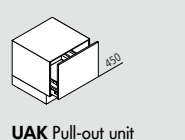
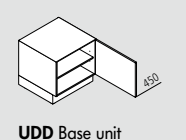
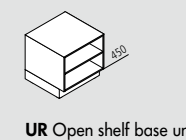
**Base units**  
600mm | 450 | 300mm

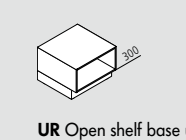
						
	<b>UDD Base unit</b>	<b>UDD Base unit</b>	<b>UATD Pull-out unit</b>	<b>UAZ Pull-out unit</b>	<b>UAZI Pull-out unit</b>	<b>USA Drawer base unit</b>
	↔ 30/35/40/45/50/60 ↓ 60 ↙ 60/50/39	↔ 80/90/100/120 ↓ 60 ↙ 60/50/39	↔ 30/40/45/50/60/80/90/100 ↓ 60 ↙ 60/50	↔ 30/40/45/50/60/80/90/100/120 ↓ 60 ↙ 60/50	↔ 30/40/45/50/60/80/90/100 ↓ 60 ↙ 60/50	↔ 30/40/45/50/60/80/90/100 ↓ 60 ↙ 60/50
						
	<b>UR Open shelf base unit</b>	<b>UAK Pull-out unit</b>	<b>UDD Base unit</b>	<b>UR Open shelf base unit</b>	<b>UAK Pull-out unit</b>	<b>UR Open shelf base unit</b>
	↔ 30/40/45/50/60 ↓ 60 ↙ 60/39	↔ 30/40/45/50/60/80/90/100/120 ↓ 45 ↙ 60/50/39	↔ 30/40/45/50/60 ↓ 45 ↙ 60/50/39	↔ 30/40/45/50/60 ↓ 45 ↙ 60/39	↔ 30/40/45/50/60/80/90/100/120 ↓ 30 ↙ 60/50/39	↔ 30/40/45/50/60 ↓ 30 ↙ 60/39

# Base units

750mm

Sink base units

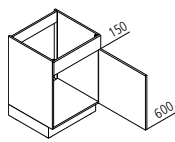

**SO** Sink base unit  
 ↳ 45/50/60  
 ↓ 75  
 ↙ 60/50

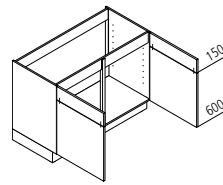

**SO** Sink base unit  
 ↳ 80/90/100/120  
 ↓ 75  
 ↙ 60/50

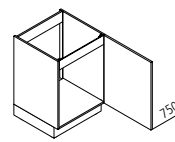

**SOD** Sink base unit  
 ↳ 45/50/60  
 ↓ 75  
 ↙ 60/50

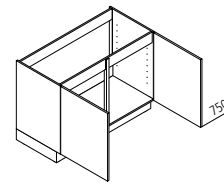

**SOD** Sink base unit  
 ↳ 80/90/100/120  
 ↓ 75  
 ↙ 60/50

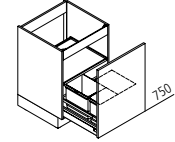

**SABD** Sink base unit with waste separation system  
 ↳ 45/50/60  
 ↓ 75  
 ↙ 60

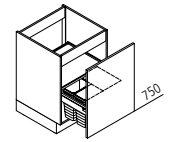

**SABHD** Sink base unit with hanging waste separation system  
 ↳ 40/45/60  
 ↓ 75  
 ↙ 60

7

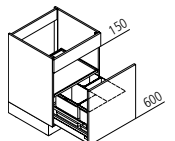

**SAB** Sink base unit with waste separation system  
 ↳ 45/50/60/80/90/100/120  
 ↓ 75  
 ↙ 60

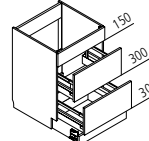

**SABS** Sink base unit with large-capacity pull-out drawer  
 ↳ 60/80/90/100  
 ↓ 75  
 ↙ 60

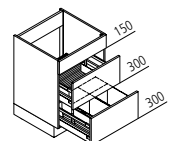

**SAKT** Sink base unit with waste separation system  
 ↳ 60/80/90/100/120  
 ↓ 75  
 ↙ 60

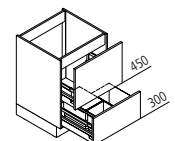

**SAZ** Sink base unit with waste separation system  
 ↳ 60/80/90/100/120  
 ↓ 75  
 ↙ 60

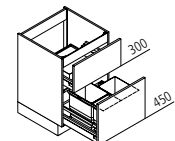

**SUZ** Sink base unit with waste separation system  
 ↳ 60/80/90/100/120  
 ↓ 75  
 ↙ 60

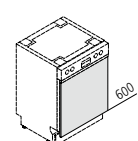

**GSB** Front panel for integrated dishwasher  
 ↳ 45/60  
 ↓ 75  
 ↙ 60

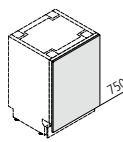

**GSBD** Front panel for fully integrated dishwasher  
 ↳ 45/60  
 ↓ 75  
 ↙ 60

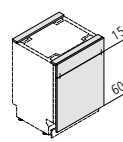

**GSBS** Front panel for fully integrated dishwasher  
 ↳ 45/60  
 ↓ 75  
 ↙ 60

Corner units

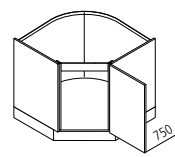

**UESD** Corner sink base unit  
 ↳ 90  
 ↓ 75  
 ↙ 60

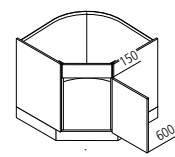

**UES** Corner sink base unit  
 ↳ 90  
 ↓ 75  
 ↙ 60

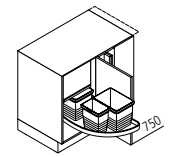

**UEPSZ** Space filler for corner sink base unit  
 ↳ 110/115/125  
 ↓ 75  
 ↙ 60

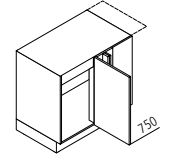

**UESAD** Space filler for corner sink base unit  
 ↳ 110/115/125  
 ↓ 75  
 ↙ 60

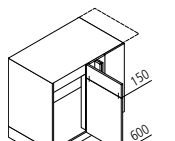

**UESA** Space filler for corner sink base unit  
 ↳ 110/115/125  
 ↓ 75  
 ↙ 60

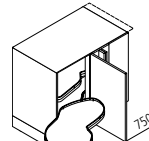

**UELAD** Corner base unit "LE MANS"  
 ↳ 110/115/125  
 ↓ 75  
 ↙ 60

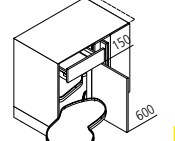

**UELA** Corner base unit  
 ↳ 110/115/125  
 ↓ 75  
 ↙ 60

6

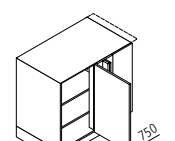

**UEEAD** Corner base unit  
 ↳ 110/115/125  
 ↓ 75  
 ↙ 60/50

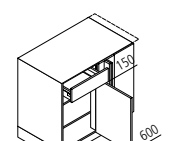

**UEEA** Corner base unit  
 ↳ 110/115/125  
 ↓ 75  
 ↙ 60/50

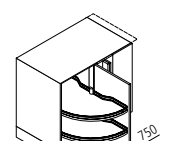

**UEAD** Corner base unit  
 ↳ 110/115/125  
 ↓ 75  
 ↙ 60

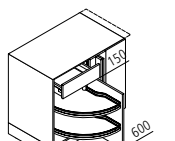

**UEA** Corner base unit  
 ↳ 110/115/125  
 ↓ 75  
 ↙ 60

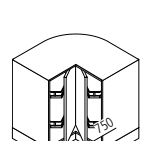

**UEK** Corner base unit  
 ↳ 80/90  
 ↓ 75  
 ↙ 60

8

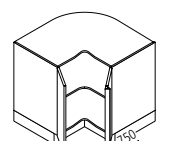

**UEKE** Corner base unit  
 ↳ 80/90  
 ↓ 75  
 ↙ 60

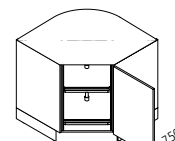

**UETD** Corner base unit  
 ↳ 90  
 ↓ 75  
 ↙ 60

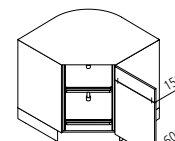

**UET** Corner base unit  
 ↳ 90  
 ↓ 75  
 ↙ 60

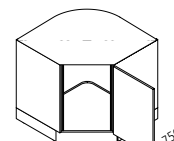

**UETDE** Corner base unit  
 ↳ 90  
 ↓ 75  
 ↙ 60

Cooker and hob base units

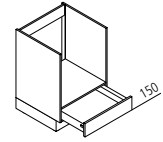

**UHSK** Cooker unit with drawer  
 ↳ 60  
 ↓ 75  
 ↙ 60

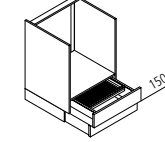

**UHS** Cooker unit with large-capacity pull-out drawer  
 ↳ 60  
 ↓ 75  
 ↙ 60

9

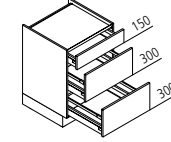

**KUAK** Hob base unit  
 ↳ 60/80/90/100/120  
 ↓ 75  
 ↙ 60

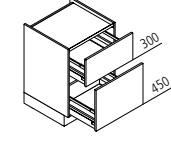

**KUZ** Hob base unit  
 ↳ 60/80/90/100/120  
 ↓ 75  
 ↙ 60

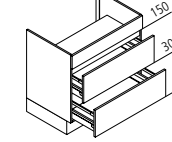

**KAK-ML** Hob base unit for use with aspiration hob  
 ↳ 60/80/90/100/120  
 ↓ 75  
 ↙ 60

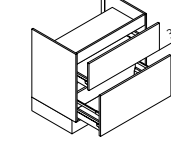

**KUZ** Hob base unit for use with aspiration hob  
 ↳ 60/80/90/100/120  
 ↓ 75  
 ↙ 60

Generate storage where space is otherwise left unused: the plinth drawer provides the answer.



6



8



9

Besides classic waste separation systems, Nolte Küchen also offers waste bins for corner units or even options for disposing of food preparation waste directly below the work surface.



7

## Base units

900mm

## Base units with glass door

750 mm | 900 mm

900 mm units

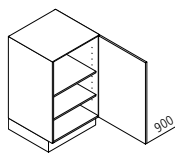

**UDD** Base unit  
 ↳ 30/40/45/50/60  
 ↓ 90  
 ↘ 60/50/39

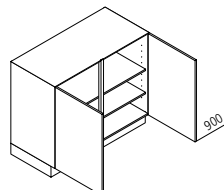

**UDD** Base unit  
 ↳ 80/90/100/120  
 ↓ 90  
 ↘ 60/50/39

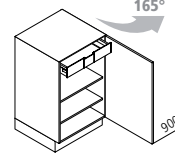

**UDDI** Base unit  
 ↳ 40/45/50/60  
 ↓ 90  
 ↘ 60/50

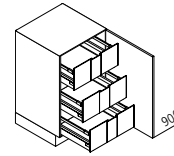

**UIADD** Base unit  
 ↳ 40/45/50/60  
 ↓ 90  
 ↘ 60/50/39

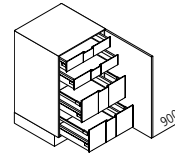

**UIDD** Base unit  
 ↳ 40/45/50/60  
 ↓ 90  
 ↘ 60/50/39

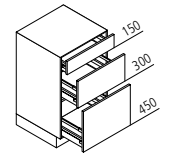

**UAK** Pull-out unit  
 ↳ 30/40/45/50/60/80/90/100/120  
 ↓ 90  
 ↘ 60/50/39

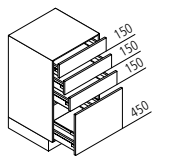

**UAS** Drawer base unit  
 ↳ 30/40/45/50/60/80/90/100  
 ↓ 90  
 ↘ 60/50/39

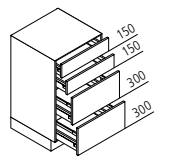

**USA** Drawer base unit  
 ↳ 30/40/45/50/60/80/90/100/120  
 ↓ 90  
 ↘ 60/50/39

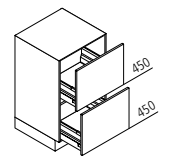

**UZ** Pull-out unit  
 ↳ 30/40/45/50/60/80/90/100/120  
 ↓ 90  
 ↘ 60/50/39

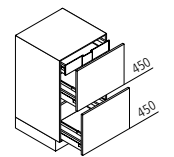

**UZI** Pull-out unit  
 ↳ 30/40/45/50/60/80/90/100/120  
 ↓ 90  
 ↘ 60/50/39

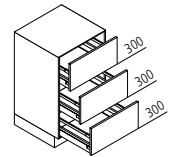

**UAZ** Pull-out unit  
 ↳ 30/40/45/50/60/80/90/100/120  
 ↓ 90  
 ↘ 60/50/39

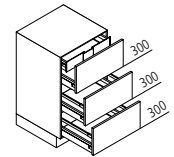

**UAZI** Pull-out unit  
 ↳ 30/40/45/50/60/80/90/100/120  
 ↓ 90  
 ↘ 60/50/39

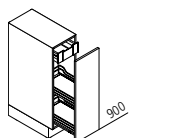

**UVK** Pull-out unit with storage baskets  
 ↳ 30  
 ↓ 90  
 ↘ 60

Corner unit

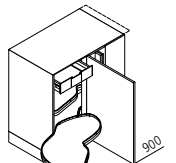

**UELAD** "LE MANS" spacefiller corner base unit  
 ↳ 110/115/125  
 ↓ 90  
 ↘ 60

Sink base units

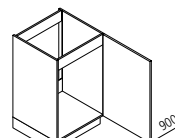

**SOD** Sink base unit  
 ↳ 45/50/60  
 ↓ 90  
 ↘ 60

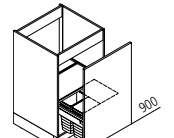

**SABHD** Sink base unit with waste separation system  
 ↳ 45/50/60  
 ↓ 90  
 ↘ 60

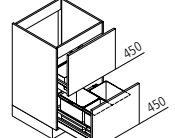

**SUZ** Sink base unit with waste separation system  
 ↳ 60/80/90/100/120  
 ↓ 90  
 ↘ 60

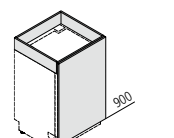

**GSBF** Front panel for fully integrated dishwasher  
 ↳ 60  
 ↓ 90  
 ↘ 60

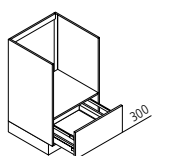

**UHAZ** Cooker unit  
 ↳ 60  
 ↓ 90  
 ↘ 60

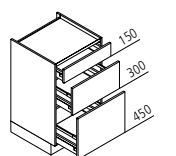

**KUAK** Hob base unit  
 ↳ 60/80/90/100/120  
 ↓ 90  
 ↘ 60

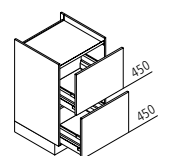

**KUZ** Hob base unit  
 ↳ 60/80/90/100/120  
 ↓ 90  
 ↘ 60

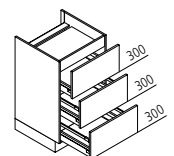

**KAZ** Hob base unit  
 ↳ 60/80/90/100/120  
 ↓ 90  
 ↘ 60

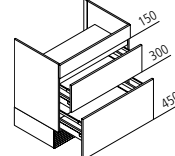

**KAK-ML** Hob base unit for use with aspiration hob  
 ↳ 60/80/90/100/120  
 ↓ 75  
 ↘ 60

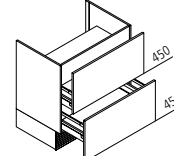

**KUZ** Hob base unit for use with aspiration hob  
 ↳ 60/80/90/100/120  
 ↓ 75  
 ↘ 60

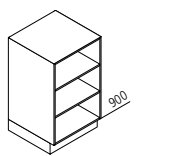

**UR** Open shelf base unit  
 ↳ 15/20/25/30/35/40/45/50/55/60  
 ↓ 90  
 ↘ 60/39

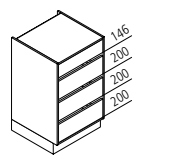

**URI** Open shelf base unit with drawers  
 ↳ 60/90  
 ↓ 90  
 ↘ 60/39

**MATRIX900**  
 by **notte** KÜCHEN

The 900 mm carcass height provides the perfect combination of ergonomics and design. With the slim-line plinth, it not only creates a completely new look but also sets new standards in storage space and ergonomics. This makes it possible to plan interesting kitchen configurations, particularly in combination with 600 mm height base unit elements.

Display units

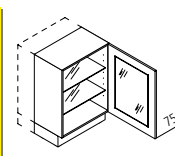

**UDDV** Base unit with glass door (depending on range)  
 ↳ 40/45/50/60  
 ↓ 75/90  
 ↘ 60/39

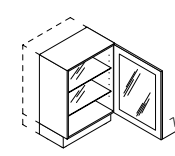

**UDDDS** Base unit with glass door **DS**  
 ↳ 40/45/50/60  
 ↓ 75/90  
 ↘ 60/39

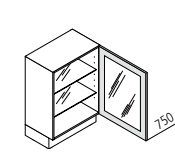

**UDDDN** Base unit with glass door **DN**  
 ↳ 40/45/50/60  
 ↓ 75/90  
 ↘ 39

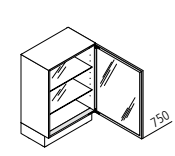

**UDDDR** Base unit with glass door **DR**  
 ↳ 40/45/50/60  
 ↓ 75/90  
 ↘ 39

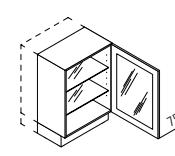

**UDDDF** Base unit with glass door **DF**  
 ↳ 40/45/50/60  
 ↓ 75/90  
 ↘ 60/39

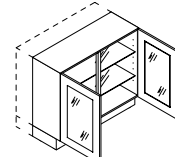

**UDDV** Base unit with glass door (depending on range)  
 ↳ 80/90/100/120  
 ↓ 75/90  
 ↘ 60/39

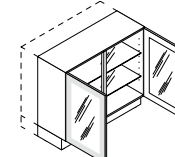

**UDDDS** Base unit with glass door **DS**  
 ↳ 80/90/100/120  
 ↓ 75/90  
 ↘ 60/39

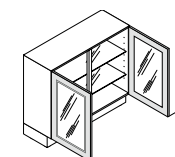

**UDDDN** Base unit with glass door **DN**  
 ↳ 80/90/100/120  
 ↓ 75/90  
 ↘ 39

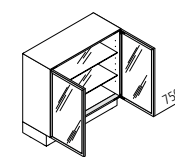

**UDDDR** Base unit with glass door **DR**  
 ↳ 80/90/100/120  
 ↓ 75/90  
 ↘ 39

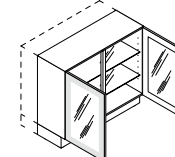

**UDDDF** Base unit with glass door **DF**  
 ↳ 80/90/100/120  
 ↓ 75/90  
 ↘ 60/39

**Note:** glass display cabinets in a carcass height of 90 cm are only available with a carcass depth of 39 cm!

## Display cabinet glass & frame designs

Glass finishes						The glass types shown here can be selected for the product-related glass doors.
	<b>KAG</b> Clear glass	<b>SAG</b> Glass satin finish	<b>FRE</b> Glass freeze	<b>KDG</b> Clear glass with wire look, black	<b>SGG</b> Tinted black glass	
Glass fronts DF						Glass fronts DS
	<b>WLG</b> White glass lacquered	<b>SWG</b> Glass satin finish grey				
Glass fronts DN						Glass fronts DR
	<b>PGB</b> Parsol glass, bronze with aluminium frame	<b>SGG</b> Tinted black glass with aluminium frame			1	



## Wall units

300 | 450 | 600 | 750 | 900  
1050 | 1200 | 1350 mm

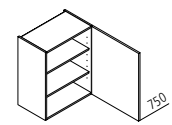

**H Wall unit**

↔ 30/40/45/50/60  
↓ 45/60/75/90/105/120/135  
↙ 35/60\*

\* = only available up to 90 cm high

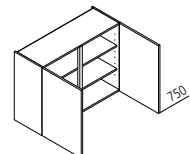

**H Wall unit**

↔ 80/90/100/120  
↓ 45/60/75/90/105/120/135  
↙ 35/60\*

\* = only available up to 90 cm high

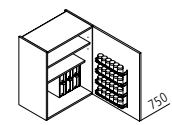

**HGL Spice cupboard**

↔ 30/40/45/50/60  
↓ 60/75/90  
↙ 35

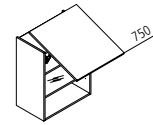

**HL Pivoting flap door unit**

↔ 45/50/60/80/90/100/120\*  
↓ 60/75  
↙ 35/60

\* = only available in 60 cm height

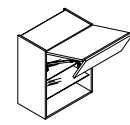

**HFK Folding top-hinged door unit**

↔ 45/50/60/80/90/100/120\*  
↓ 60/75  
↙ 35/60

\* = only available in 60 cm height

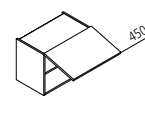

**HK Wall unit**

↔ 45/50/60/80/90/100/120  
↓ 45  
↙ 35/60

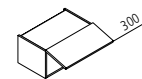

**H Wall unit**

↔ 30/40/45/50/60/80/90/100/120  
↓ 30  
↙ 35/60



**HBF Wall unit with bar flap**

↔ 60/80/90/100/120  
↓ 30/45  
↙ 35/50

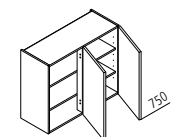

**HEK Wall unit**

↔ 80/90  
↓ 60/75/90  
↙ 35

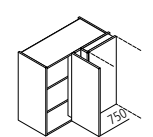

**HES Corner wall unit**

↔ 80/90  
↓ 60/75/90  
↙ 35

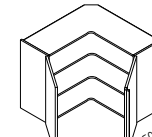

**HE Corner wall unit**

↔ 65/80/90  
↓ 60/75/90  
↙ 35

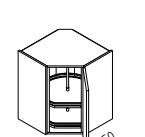

**HET Corner wall unit**

↔ 60  
↓ 60/75/90  
↙ 35

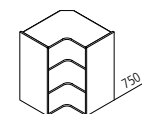

**HER Corner wall shelf unit**

↔ 60/65  
↓ 60/75/90  
↙ 35

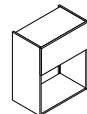

**HM Wall unit for microwave**

↔ 50/60  
↓ 60/75/90/105  
↙ 35

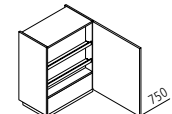

**HWU Wall unit for integrated extractor hood**

↔ 60  
↓ 45/60/75/90/105  
↙ 35

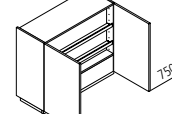

**HWU Wall unit for integrated extractor hood**

↔ 90  
↓ 45/60/75/90/105  
↙ 35

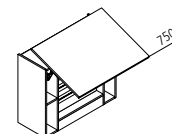

**HWUL Pivoting flap door unit for integrated extractor hood**

↔ 80/90/100/120\*  
↓ 60/75  
↙ 35

\* = only available in 60 cm height

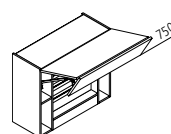

**HWUFK Folding top-hinged door unit for integrated extractor hood**

↔ 80/90/100/120\*  
↓ 60/75  
↙ 35

\* = only available in 60 cm height

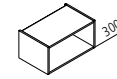

**HR Wall shelf unit**

↔ 30/40/45/50/60/80/90/100/120  
↓ 30  
↙ 35



**HRV Wall shelf unit with glass**

↔ 60/90/120  
↓ 30/45  
↙ 35

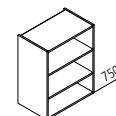

**HR Wall shelf unit**

↔ 15/20/25/30/35/40/45/50/55/60  
↓ 45/60/75/90/105  
↙ 35



**HF Wall unit bottle rack**

↔ 15  
↓ 60/75/90  
↙ 35

Matrix 150 even gives 350 mm deep wall units enough space to store large pasta plates.



1



2

Besides the product-related glass doors, you can also choose from other design options. Please go to page 45 for the various glass types and frame designs.

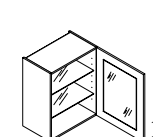

**HV Wall unit with glass door (depending on range)**

↔ 40/45/50/60  
↓ 60/75/90  
↙ 35

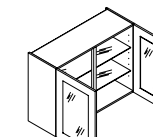

**HV Wall unit with glass door (depending on range)**

↔ 80/90/100/120  
↓ 60/75/90  
↙ 35

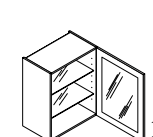

**HVDS Wall unit with glass door DS**

↔ 40/45/50/60  
↓ 60/75/90/105  
↙ 35

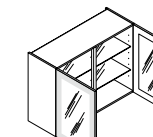

**HVDS Wall unit with glass door DS**

↔ 80/90/100/120  
↓ 60/75/90  
↙ 35

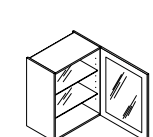

**HVDF Wall unit with glass door DF**

↔ 40/45/50/60  
↓ 60/75/90  
↙ 35

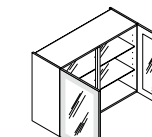

**HVDF Wall unit with glass door DF**

↔ 80/90/100/120  
↓ 60/75/90  
↙ 35

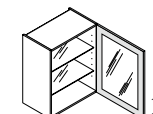

**HVDN Wall unit with glass door DN**

↔ 40/45/50/60  
↓ 60/75/90/105  
↙ 35

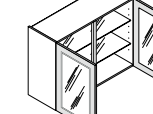

**HVDN Wall unit with glass door DN**

↔ 80/90/100/120  
↓ 60/75/90  
↙ 35

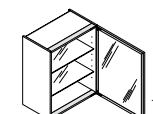

**HVDR Wall unit with glass door DR**

↔ 40/45/50/60  
↓ 60/75/90/105/120/135  
↙ 35

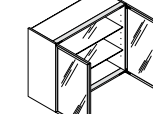

**HVDR Wall unit with glass door DR**

↔ 80/90/100/120  
↓ 60/75/90  
↙ 35

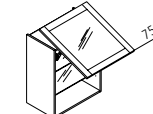

**HLV Pivoting flap door unit with glass (depending on range)**

↔ 45/50/60/80/90/100/120\*  
↓ 60/75  
↙ 35

\* = only available in 60 cm height

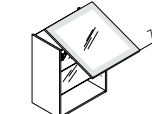

**HLDS Pivoting flap door unit with glass DS**

↔ 45/50/60/80/90/100/120\*  
↓ 60/75  
↙ 35

\* = only available in 60 cm height

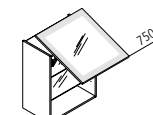

**HLDV Pivoting flap door unit with glass DF**

↔ 45/50/60/80/90/100/120\*  
↓ 60/75  
↙ 35

\* = nur in 60 cm Höhe lieferbar

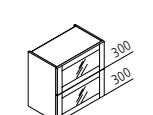

**HFKV Folding top-hinged door unit with glass (depending on range)**

↔ 45/50/60/80/90/100/120  
↓ 60  
↙ 35

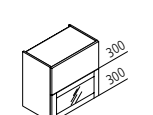

**HFKVPU Folding top-hinged door unit with glass (depending on range)**

↔ 45/50/60/80/90/100/120  
↓ 60/75  
↙ 35

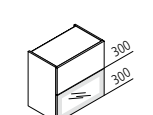

**HFKDPU Folding top-hinged door unit with glass DS**

↔ 45/50/60/80/90/100/120  
↓ 60/75  
↙ 35

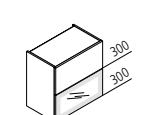

**HFKDPU Folding top-hinged door unit with glass DF**

↔ 45/50/60/80/90/100/120  
↓ 60/75  
↙ 35

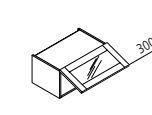

**HV Wall unit with glass (depending on range)**

↔ 45/50/60/80/90/100/120  
↓ 30  
↙ 35

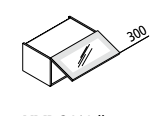

**HVDS Wall unit with glass DS**

↔ 45/50/60/80/90/100/120  
↓ 30  
↙ 35

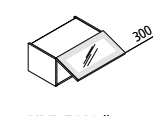

**HVDF Wall unit with glass DF**

↔ 45/50/60/80/90/100/120  
↓ 30  
↙ 35

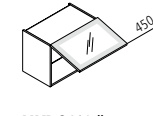

**HKDS Wall unit with glass DS**

↔ 60/80/90/100/120  
↓ 45  
↙ 35

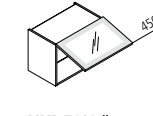

**HKDF Wall unit with glass DF**

↔ 60/80/90/100/120  
↓ 45  
↙ 35

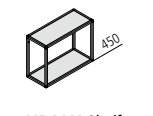

**HRALU Shelf system, aluminium, black / stainless steel look**

↔ 60/90/120  
↓ 30/45/60  
↙ 35

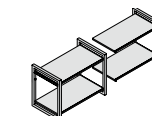

**HRM Shelf system, metal, black - expandable**

↔ 60  
↓ 45  
↙ 35

Dresser units  
1150 | 1300 | 1450 mm

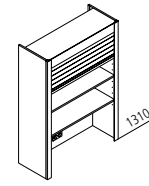

**H AJ Dresser unit with shutter in metallic finish**  
↔ 50/60/80/90  
↓ 115/130/145  
↖ 35/50/60

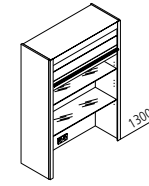

**H AJGO Dresser unit with glass-look shutters**  
↔ 60/90  
↓ 115/130/145  
↖ 35/50/60  
Available in black soft mat or black high-gloss

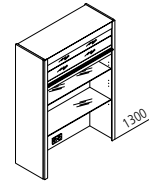

**H AJV Dresser unit with glass-louvres**  
↔ 50/60/80/90  
↓ 115/130/145  
↖ 35/50/60

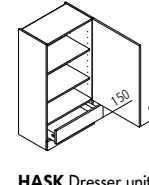

**HASK Dresser unit**  
↔ 45/50/60  
↓ 115  
↖ 35

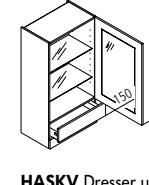

**HASKV Dresser unit with glass door (depending on range)**  
↔ 45/50/60  
↓ 115  
↖ 35

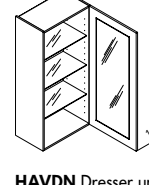

**H AVDN Dresser unit with glass door DN**  
↔ 45/50/60  
↓ 115/130/145  
↖ 35

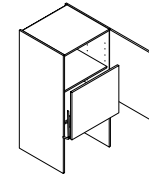

**H AL Dresser unit with top hinged door**  
↔ 60  
↓ 115/130/145  
↖ 60

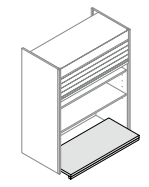

**H AAB Pull-out shelf with TipOn for dresser units**  
↔ 50/60/80/90  
↖ 50/60

**Planning tip:**  
The final height of the top-mounted cabinets shown here is automatically matched to suit the worktop thickness!



Larder units and appliance housings  
1500 mm

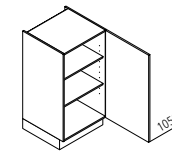

**V Larder unit**  
↔ 30/40/45/50/60  
↓ 105  
↖ 60/50/35

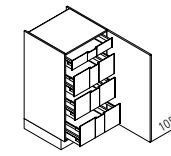

**VI Larder unit**  
↔ 40/45/50/60  
↓ 105  
↖ 60/50/35

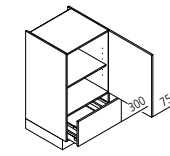

**VA Larder unit**  
↔ 30/40/45/50/60  
↓ 105  
↖ 60/50

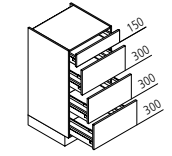

**VAK Larder unit**  
↔ 30/40/45/50/60  
↓ 105  
↖ 60/50

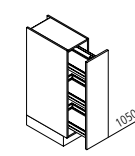

**VVA Larder unit**  
↔ 30/40  
↓ 105  
↖ 60

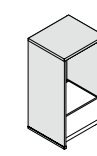

**WA-GUB Panelling for elevated dishwasher**  
↔ 60  
↓ 105  
↖ 60

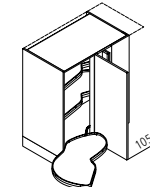

**VELA Corner larder unit**  
↔ 110/115/125  
↓ 105  
↖ 60

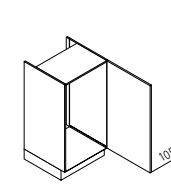

**GK Appliance housing for refrigerator / recess 1025 mm**  
↔ 60  
↓ 105  
↖ 60

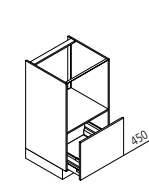

**GBZ Appliance housing for oven or microwave**  
↔ 60  
↓ 105  
↖ 60

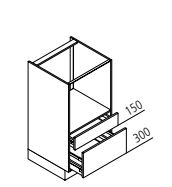

**GBAS Appliance housing for oven or microwave**  
↔ 60  
↓ 105  
↖ 60

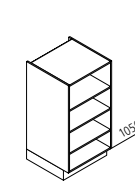

**SR Open shelf units**  
↔ 20/25/30/40/45/50/60  
↓ 105  
↖ 60

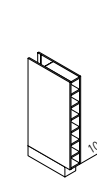

**SF Bottle rack**  
↔ 15  
↓ 105  
↖ 60



Simply turn your appliance housings into a sideboard: the tall-unit height of 1050 mm gives you even more ways of opening up the design of the kitchen.

# Larder units and appliance housings

1350 | 1500 mm

The drawings show 1500 mm carcass height.

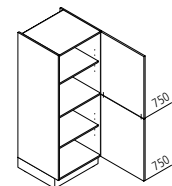

**V** Larder unit  
 ↔ 30/40/45/50/60  
 ↓ 135/150  
 ↙ 60/50/35

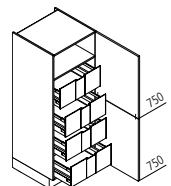

**VI** Larder unit  
 ↔ 40/45/50/60  
 ↓ 135/150  
 ↙ 60/50/35

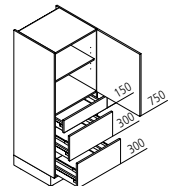

**VAK** Larder unit  
 ↔ 30/40/45/50/60  
 ↓ 135/150  
 ↙ 60/50

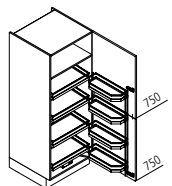

**VVK** Larder unit  
 ↔ 60  
 ↓ 135/150  
 ↙ 60

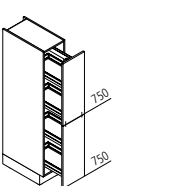

**VVA** Larder unit  
 ↔ 30/40  
 ↓ 135/150  
 ↙ 60



1



2



3



4

# Larder units and appliance housings

1950 | 2100 | 2250 mm

The drawings show 1500 mm carcass height.

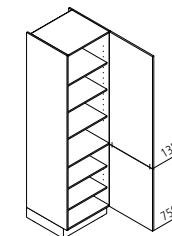

**V** Larder unit  
 ↔ 30/40/45/50/60  
 ↓ 195/210/225  
 ↙ 60/50/35

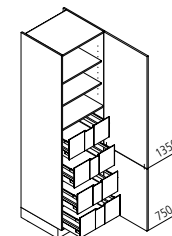

**VI** Larder unit  
 ↔ 40/45/50/60  
 ↓ 195/210/225  
 ↙ 60/50/35

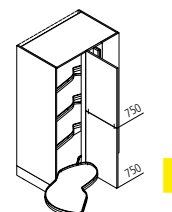

**VELA** Corner larder unit  
 ↔ 110/115/125  
 ↓ 135/150  
 ↙ 60

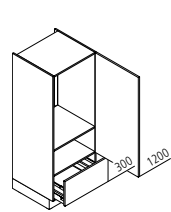

**GKA** Appliance housing for refrigerator / recess 880 mm  
 ↔ 60  
 ↓ 135/150  
 ↙ 60

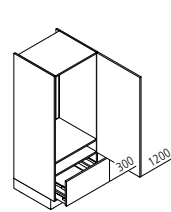

**GKA** Appliance housing for refrigerator / recess 1025 mm  
 ↔ 60  
 ↓ 135/150  
 ↙ 60

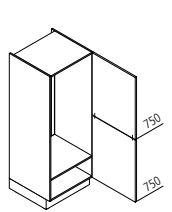

**GK** Appliance housing for refrigerator / recess 1225 mm  
 ↔ 60  
 ↓ 135/150  
 ↙ 60

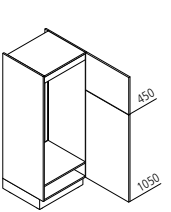

**GKG** Appliance housing for fridge/freezer combination / recess 1225 mm  
 ↔ 60  
 ↓ 135/150  
 ↙ 60

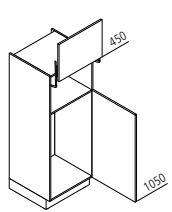

**GKL** Appliance housing with lift-up door for refrigerator / microwave / recess 880 mm  
 ↓ 135/150  
 ↙ 60

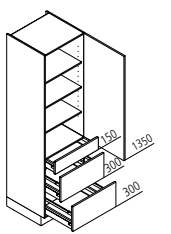

**VAK** Larder unit  
 ↔ 30/40/45/50/60  
 ↓ 195/210/225  
 ↙ 60/50

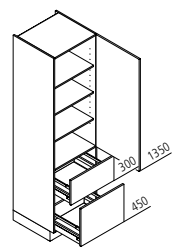

**VZ** Larder unit  
 ↔ 30/40/45/50/60  
 ↓ 195/210/225  
 ↙ 60/50

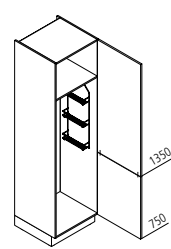

**VB** Broom cupboard  
 ↔ 30/40/45/50/60  
 ↓ 195/210/225  
 ↙ 60/50

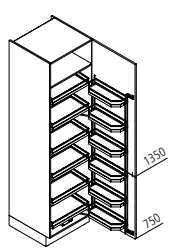

**VVK** Larder unit  
 ↔ 60  
 ↓ 195/210/225  
 ↙ 60

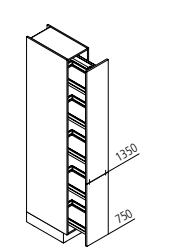

**VVA** Larder unit  
 ↔ 30/40  
 ↓ 195/210/225  
 ↙ 60

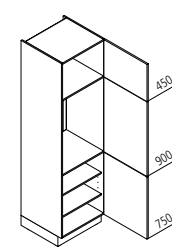

**GK** Appliance housing for refrigerator / recess 880 mm  
 ↔ 60  
 ↓ 195/210/225  
 ↙ 60

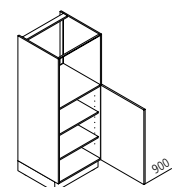

**GB** Appliance housing for oven or microwave  
 ↔ 60  
 ↓ 135/150  
 ↙ 60

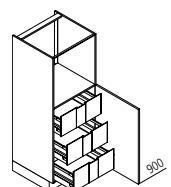

**GBI** Appliance housing for oven or microwave  
 ↔ 60  
 ↓ 135/150  
 ↙ 60

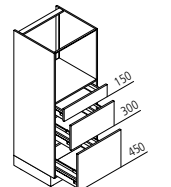

**GBZ** Appliance housing for oven or microwave  
 ↔ 60  
 ↓ 135/150  
 ↙ 60

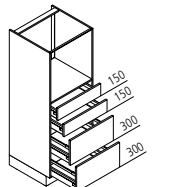

**GBAK** Appliance housing for oven or microwave  
 ↔ 60  
 ↓ 135/150  
 ↙ 60

## Planning information!

This example shows you how units vary in relation to carcass height:

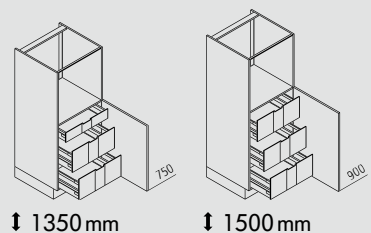

Appliance housings always adapt to the appliances fitted in them. Depending on make and appliance height, the units shown here can be varied in terms of front layout and number of drawers or pull-outs.

To give you an overall picture of the extensive range of storage units and appliance housings you can choose from, we have summarised the available carcass heights here in one illustration which shows only a selection of appliance housings.

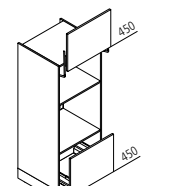

**GBLA** Appliance housing with lift-up door for oven and microwave  
 ↔ 60  
 ↓ 135/150  
 ↙ 60

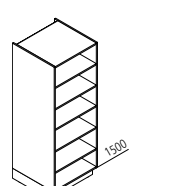

**SR** Open shelf units  
 ↔ 20/25/30/35/40/45/50/55/60  
 ↓ 135/150  
 ↙ 60

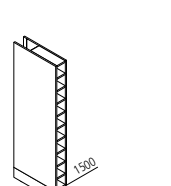

**SF** Bottle rack  
 ↔ 15  
 ↓ 135/150  
 ↙ 60

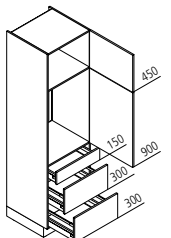

**GKAK** Appliance housing for refrigerator / recess 880 mm  
 ↔ 60  
 ↓ 195/210/225  
 ↙ 60

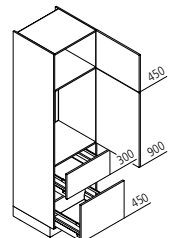

**GKZ** Appliance housing for refrigerator / recess 880 mm  
 ↔ 60  
 ↓ 195/210/225  
 ↙ 60

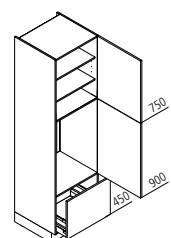

**GKA** Appliance housing for refrigerator / recess 880 mm  
 ↔ 60  
 ↓ 195/210/225  
 ↙ 60

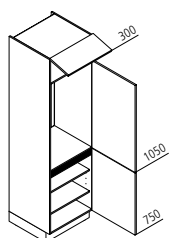

**GK** Appliance housing for refrigerator / recess 1025 mm  
 ↔ 60  
 ↓ 195/210/225  
 ↙ 60

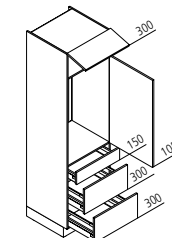

**GKAK** Appliance housing for refrigerator / recess 1025 mm  
 ↔ 60  
 ↓ 195/210/225  
 ↙ 60

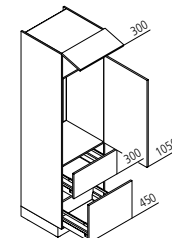

**GKZ** Appliance housing for refrigerator / recess 1025 mm  
 ↔ 60  
 ↓ 195/210/225  
 ↙ 60

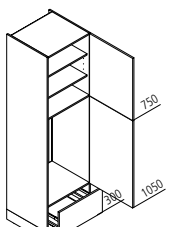

**GKA** Appliance housing for refrigerator / recess 1025 mm  
 ↔ 60  
 ↓ 195/210/225  
 ↙ 60

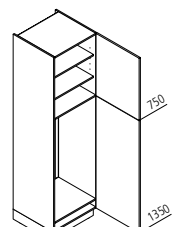

**GK** Appliance housing for refrigerator / recess 1225 mm  
 ↔ 60  
 ↓ 195/210/225  
 ↙ 60

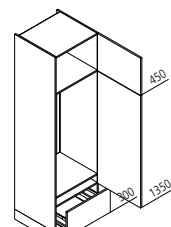

**GKA** Appliance housing for refrigerator / recess 1225 mm  
 ↔ 60  
 ↓ 195/210/225  
 ↙ 60

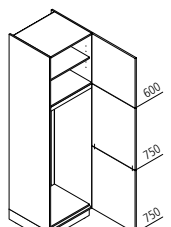

**GK** Appliance housing for refrigerator / recess 1440 mm  
 ↔ 60  
 ↓ 195/210/225  
 ↙ 60

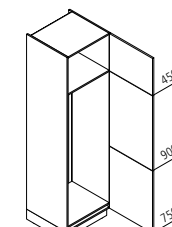

**GKG** Appliance housing for fridge/freezer combination / recess 1580 mm  
 ↓ 195/210/225  
 ↙ 60

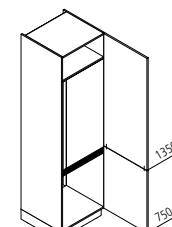

**GK** Appliance housing for refrigerator / recess 1780 mm  
 ↔ 60  
 ↓ 195/210/225  
 ↙ 60

# Larder units and appliance housings

1950 | 2100 | 2250 mm

The drawings show  
2100 mm carcass height.

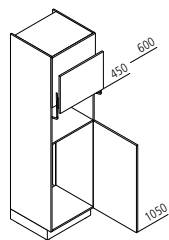

**GKL** Appliance housing with lift-up door for refrigerator / microwave / recess 1025 mm  
 ← 60  
 ↓ 195/210/225  
 ↙ 60

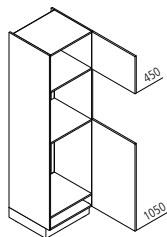

**GKB** Appliance housing for refrigerator and oven / recess 880 mm  
 ← 60  
 ↓ 195/210/225  
 ↙ 60

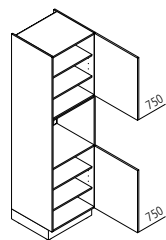

**GB** Appliance housing for oven / microwave  
 ← 60  
 ↓ 195/210/225  
 ↙ 60

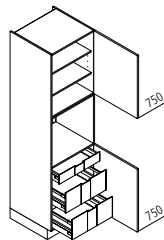

**GBI** Appliance housing for oven / microwave  
 ← 60  
 ↓ 195/210/225  
 ↙ 60

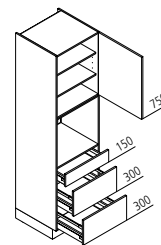

**GBAK** Appliance housing for oven / microwave  
 ← 60  
 ↓ 195/210/225  
 ↙ 60

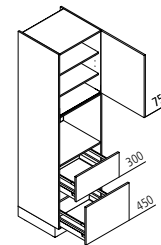

**GBZ** Appliance housing for oven / microwave  
 ← 60  
 ↓ 195/210/225  
 ↙ 60

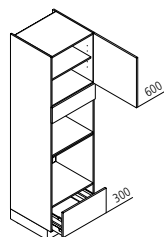

**GBBA** Appliance housing for oven / microwave  
 ← 60  
 ↓ 195/210/225  
 ↙ 60

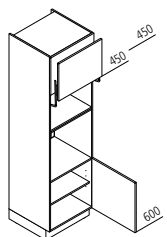

**GBL** Appliance housing with lift-up door for oven / microwave  
 ← 60  
 ↓ 195/210/225  
 ↙ 60

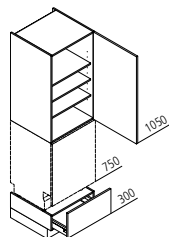

**GGS A** Appliance housing surround for dishwasher  
 ← 60  
 ↓ 195/210/225  
 ↙ 60

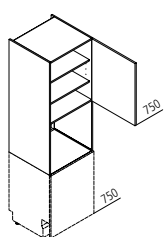

**GGS B** Appliance housing surround for dishwasher / oven  
 ← 60  
 ↓ 195/210/225  
 ↙ 60

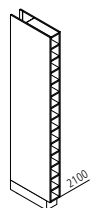

**SF** Bottle rack

← 15  
 ↓ 195/210/225  
 ↙ 60

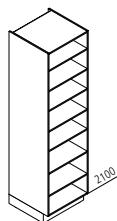

**SR** Open shelf units

← 20/25/30/35/40/45/50/55/60  
 ↓ 195/210/225  
 ↙ 60

## Planning information!

To give you an overall picture of the extensive range you can choose from, we have summarised the available carcass heights here in one illustration which shows only a selection of appliance housings.

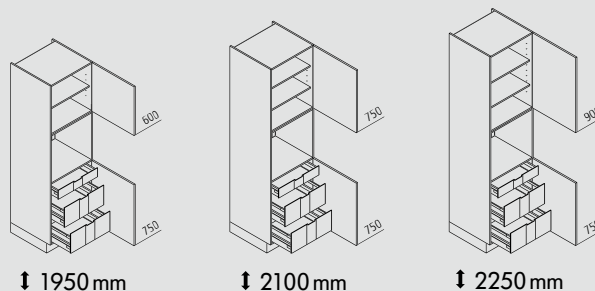

The example on the left shows you how units vary in relation to carcass height:

Appliance housings always adapt to the appliances fitted in them. Depending on make and appliance height, the units shown here can be varied in terms of front layout and number of drawers or pull-outs.

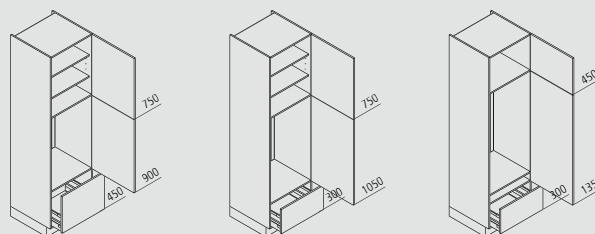

By way of example, an appliance housing for a refrigerator in 2100 mm height with recess heights of 880, 1025 and 1225 mm (from left to right).